

MACHINE MODEL

XT4

Automatic bandsaws for industry application

Short description

XT Series are the latest and more advanced professional tools developed by IMET technicians for industry application and massive production of steel and metal solids: XT4 is an automatic double column bandsaw with straight cut with automatic cutting parameters, touch screen display, innovative design to guarantee user safety during the entire cutting process



Scan the video



Cutting area	90°
Cutting capacity at 90°	Round: 360mm - Squared: 360mm - Rectangular: 360x360mm
Capacity with bundle cutting	350x350mm - 90x10mm (scrap-end with bundle: 210mm)
Minimum scrap-end	60mm (available in option 30mm)
Minimum cutting diameter	20mm
Blade size	5900x41x1.3mm
Blade inclination	0°
Blade motor power	5.5KW
Blade speed	15÷150 m/min
Sawframe motoreducer	Brushless 1/9 6Nm low backlash planetary
Feeder motoreducer	Brushless 1/25 6Nm low backlash planetary
Feeder length	500 mm
Hydraulic unit power	2.2KW
Hydraulic unit tank capacity	60l
Collant tank capacity	100l
Weight	3500kg



Addison Saws Ltd
 01384 264950
 sales@addisonsaws.co.uk
 www.addisonsaws.co.uk

Addison

XT4

sawing technology

Machine size .	2800x1777x2200mm
Minimum cutting length	10 mm
Working table height	870mm
Chips conveyor height	420mm

Features



Innovative design

Innovative, fascinating and clean: these are the main features of the XT Series design that provided to these machineries the prestigious ADI (Italy's association dedicated to best product of the italian industrial design) Design Index selection and the publication on the renowned ADI magazine as one of the best product of the italian design. XT Series was also officially selected to be a contestant for the Golden Compass, the mos famous italian design award.



10" touch screen display

XT Series uses CNC numeric control to managed all the machine settings. The machine is also equipped with a simple and easy-to-use 10" touch screen display with user-friendly and intuitive interface that gives the operator full control on all the machine operative parameters, increasing and optimizing the user-experience, making the machine the ideal working tool in professional environment for industry application.



Automatic settings and materials library

Inside the machine it's has been uploaded a material library with more than 150 materials with preset parameters and cutting settings, fully accessible through the touch screen and the easy-to-use machine interface; the library allows to start cutting even with no experiece, the user just need to follow the intuitive instruction: just few clicks to select the material and the cutting program, then XT software will calculate cutting settings to optimize the process and start the production.



sawing technology

Addison Saws Ltd
01384 264950
sales@addisonsaws.co.uk
www.addisonsaws.co.uk

Addison

XT4

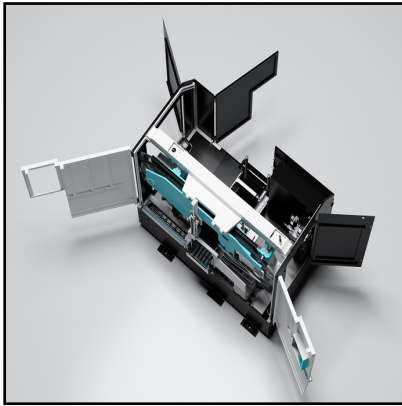

User safety

User safety is provided by the new design full carter system which cover all the machine moving parts while the machine is working so that the user cannot be in danger. In case of the opening of a carter, the machine has microswitch system that immediately stops the movements. Every working error or breakage is indicated on the display.

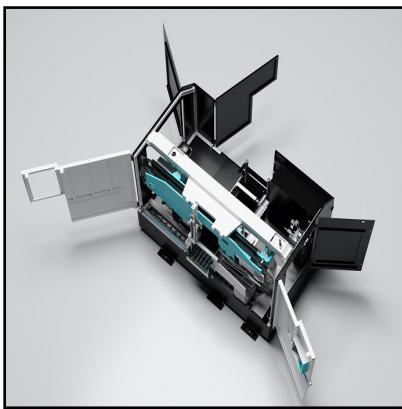

Full access

The protection system doesn't mean it's not easy to intervene in case of maintenance: all the carters can open up, providing full access to all the internal machine parts. A sump pump provides for the collecting tank cleaning.

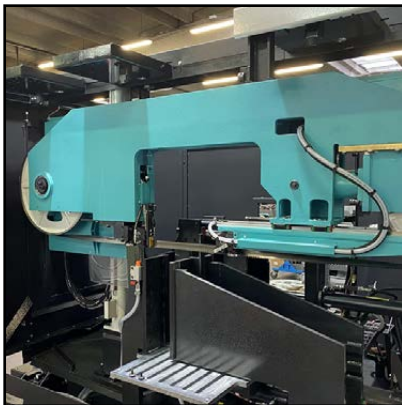

Double structure sawframe

XT Series sawframe has a rigid double structure in electrowelded steel specifically designed to have the highest resistance even on the biggest cutting processes; this massive structure reduces vibrations, bindings and noises while working, optimizing performances on all kind of materials and shapes.

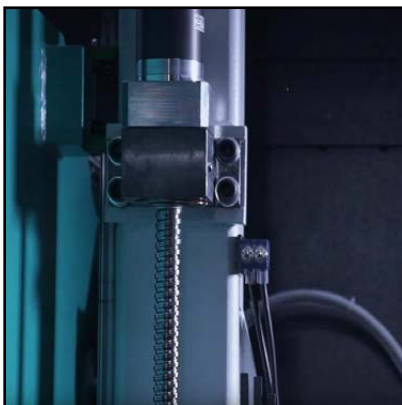

Sawframe movement

Sawframe movement is perfectly balanced and provided by a high performance brushless low backlash planetary gearbox motor with recyrculating ballscrew and 6 Nm. Sawframe also slides on two linear guides (one for each side). Thanks to this high accurate sawframe movement, it's possible to increase sawframe descent speed control precision with better rates even on lower rates.

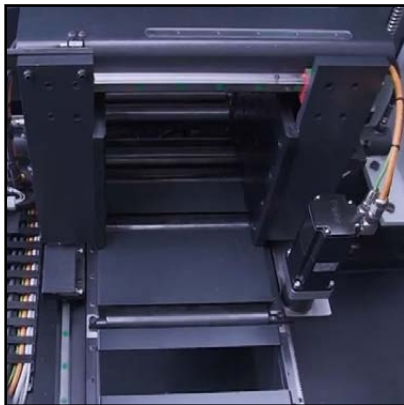

Integrated feeder

The material is placed on the integrated roller table (500mm with stroke repetition, equipped with rack and pinion to ideal position and speed control) and locked by the vice jaws that have the unique feature to open on both sides so that feeding process is optimized even on non-rectilinear bars. The feeder has a brushless low backlash planetary gearbox and slides on rectified guides and recirculating ballscrews runners.



Vice

OPTIONAL

Blocking vice provides for the perfect material locking and is equipped with an innovative system that allows to open all 4 jaws independently; this helps to load even not-rectilinear bars. The user can choose between two main configuration for the vice: 4 jaws (2 placed before the blade and 2 after) or with 2 jaws place only after the blade.

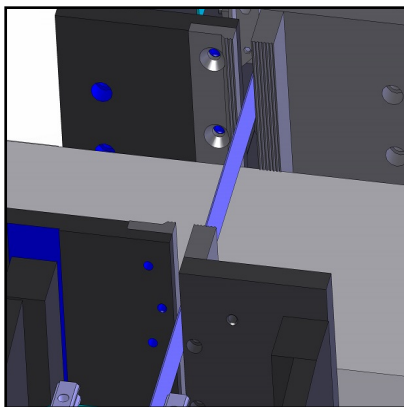

Vice: 4 jaws

OPTIONAL

This configuration presents 4 jaws: 2 lock the material before the blade and 2 after the cut. We strongly suggest this configuration in case the user wants to use hard metal blade (WIDIA) so that the stability is increased during the cutting process. Minimum scrap end: 60mm.

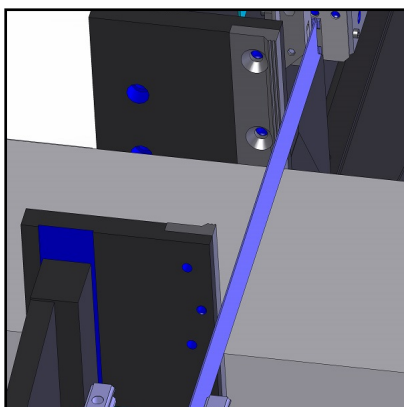

Vice: 2 jaws

OPTIONAL

The user can select this configuration with 2 jaws on the vice placed only after the blade so that the material is locked only after the cut line. This configuration allows to reduce the scrap end to just 30mm

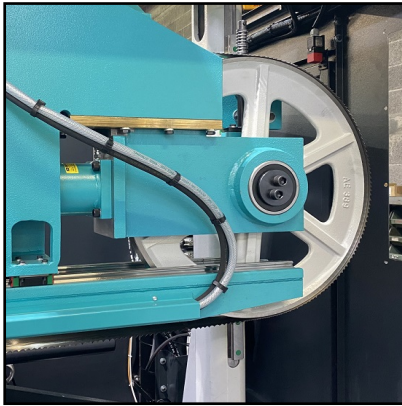

Blade tension

OPTIONAL

Hydraulic cylinder driven blade tension is also managed by the bandsaw software. If the machine has been used for some period, the control system provides to release the band (reducing tension) to avoid strain. In case of breakage, the control commands an immediate stops to the process with alarm on display.

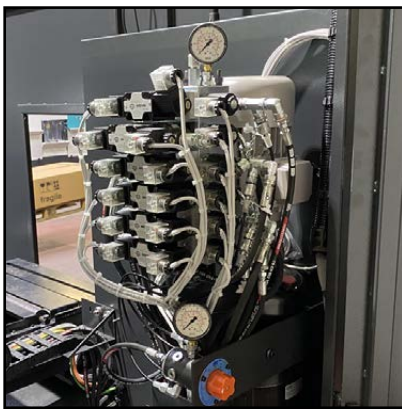

Saving energy

OPTIONAL

The XT Series innovative hydraulic unit allows to save the 80% of the energy consumption compared to traditional unit: our power unit uses 3 Kw/h a day while other units consumption is 16 Kw/h per day. This allows to save up to 400 euro per year (the data has been calculated on a 8 hour per day functioning, 220 working days per year).



Detach system

OPTIONAL

Once the cut ends, the feeder backs off and the system allows to detach the blade from the material before bow rises. This process helps reduce the friction between blade and cut piece and increase dramatically the cutting efficiency of your machine helping to save blade life when using hard metal bands and/or bundle cutting device

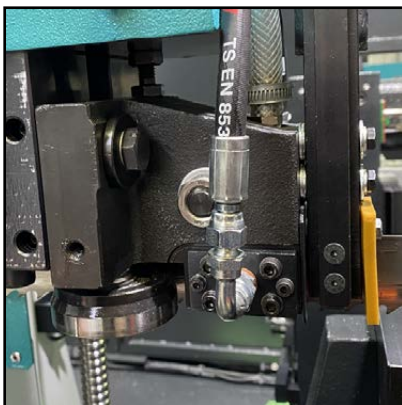

Blade guides

OPTIONAL

Hard metal pads blade guides hydraulically kept in touch with the band; blade-guides are equipped with cemented, hardened, rectified lateral guide rolls with easy regulation. Inside the blade-guide there's a wide-ring bearing leaning on the blade back to provide the best alignment, saving the bearing life.



sawing technology

Addison Saws Ltd
01384 264950
sales@addisonsaws.co.uk
www.addisonsaws.co.uk

Addison

XT4

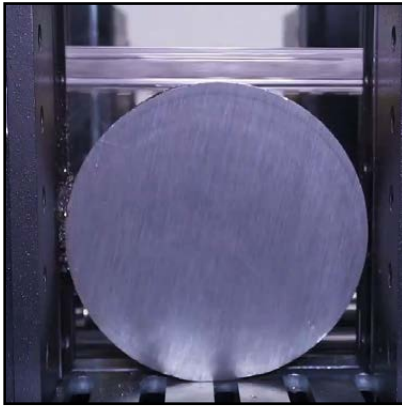

IMET SENSE

OPTIONAL

IMET Sense allows to speed-up cutting times optimizing the band fast approach to the material: once the blade comes at 10mm to the piece, the machine uses the faster cutting parameters (added in the material parameters table) that have been applied to that material.



Chip conveyor

OPTIONAL

XT Series machines are equipped with a standard chip conveyor with 420mm height evacuation



Industry 4.0 Ready - SAWFACTORY (Optional)

OPTIONAL

IMET automatic machines can be connected to the company network and be used remotely thanks SAWFACTORY and modem. SAWFACTORY is a dedicated software which allows to manage the cutting process from the office desk by setting cutting programs and monitoring the workflow thanks to the dedicated web app. The software also allows to also receive assistance by our technicians remotely. Discover SAWFACTORY: <https://bit.ly/2RuxHuX>

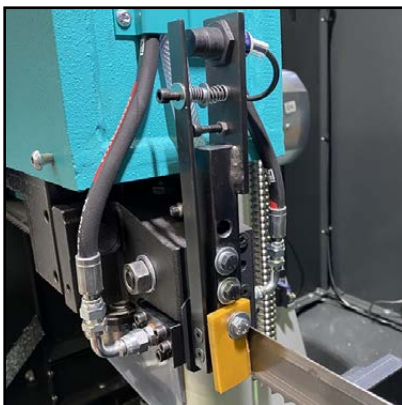

Deluxe kit: blade deviation control (Optional)

OPTIONAL

Deluxe kit includes in one option both the blade deviation control and the Smart Start device. Blade deviation control allows to always cut with perfect tolerance up to the end of band life; the machine tries to correctly align the blade, allowing to start cutting always with the right settings (automatic regulation of the cutting parameters). If an error is detected, the cut doesn't start.



Deluxe Kit: SMART START (Optional)

OPTIONAL

Together with blade deviation control, SMART START device allows to choose between two options to set up the first cut: the user can set the first cut length and the material is automatically positioned by the machine; if the first cut is not needed, the machine automatically start with the set cutting program.



Supplimentary chip conveyor (Optional)

OPTIONAL

It's possible to have a supplementary chip conveyor with increased height at 930mm.

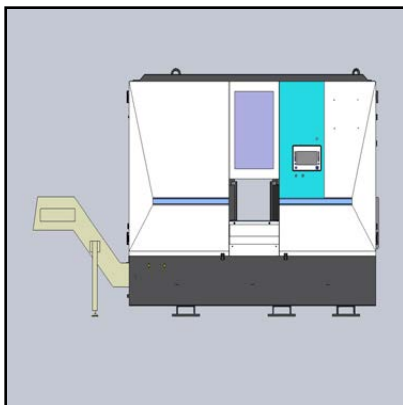

Carpet chip conveyor (Optional)

OPTIONAL

Automatic XT Series machine have the possibility to use a carpet chip conveyor instead of the standard one. It's possible to install it on both side of the machine depends on the customer needs.



Minimal lubrication system (Optional)

OPTIONAL

It is possible to require, for all Imet machines, the minimal lubrication system, it avoids the dispersion of refrigerant liquid typical in the use of emulsifiable oil, the life of the blade is not in any way affected. Minimal lubrication system has a 3 liters capacity.

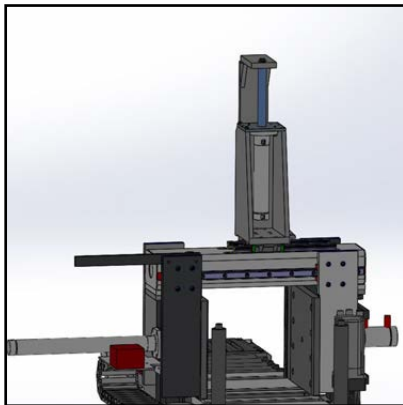

Bundle cutting device (Optional)

OPTIONAL

Hydraulic bundle cutting device for XT5 bandsas (max 350x350mm - min 90x10mm). Minimum scrap-end with bundle device is 210 mm.

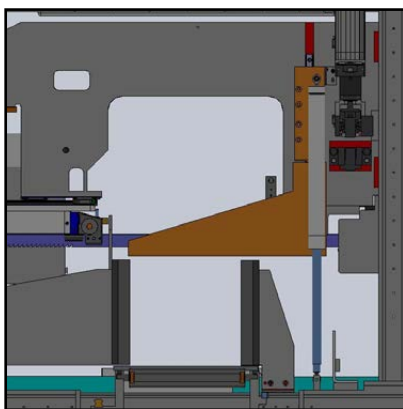

How to use bundle device (Optional)

OPTIONAL

The device includes two vertical cylinder with 2 horizontal metal bar placed transversely. To use it with a minimal scrap-end of 100mm, it's possible to remove the vice bar by working on its screws, otherwise the scrap-end is 210mm.

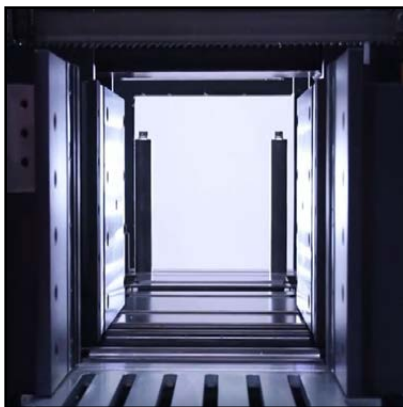

Supplementary feeder length (Optional)

OPTIONAL

It's possible to require a feeder with supplementary length compared to the standard 500mm



Loadin/unloading roller table (Optional)

OPTIONAL

Loading and unloading roller table for XT5 with free rolls and 2 vertical rolls. Single module length 2m.



sawing technology

Addison Saws Ltd
01384 264950
sales@addisonsaws.co.uk
www.addisonsaws.co.uk

Addison

XT4



Roller table for bundle cutting (Optional)

OPTIONAL

Loading and unloading roller table with containment vertical roll with adjustable width. Single module length is 2m. This model is compatible with bundle cutting, also equipped with trail to collect remaining and liquid

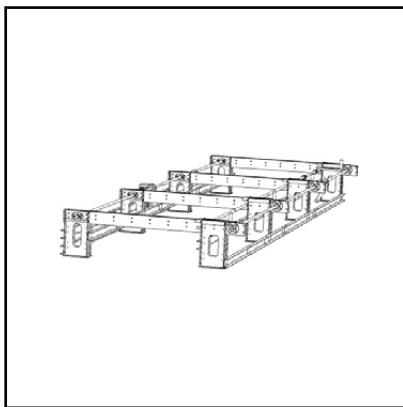

Automatic warehouse system (Optional)

OPTIONAL

Automatic bar warehouse driven by the saw control software where the bars are automatically fed, consisting of supporting surfaces with a drag chain and loading stations (from 5 to 15). The supporting surfaces can be easily moved thanks to a modular structure. The feeder is provided with a system of blockage of the bar and with vertical aligning rollers and gearboxes to move the drag chains. The system is driven by the software.